

# SEAGULL 1570MM SEAPLANE

## BUILDING INSTRUCTIONS



## CATALOG

Contents of Kit -----P1

BUILDING INSTRUCTION-----P2-P20



# CONTENTS

## 1 x Un-assembled Seagull kit.

### INCLUDES:

- |                         |                            |
|-------------------------|----------------------------|
| 1 x Plywood sheets pack | 1 x Paulownia strips       |
| 1 x Balsa sheets pack   | 1 x Construction drawing   |
| 1 x Balsa sticks pack   | 1 x Operation manual       |
| 1 x Hardwood strips     | 1 x Set of Connecting rods |
| 1 x Accessories bag     |                            |

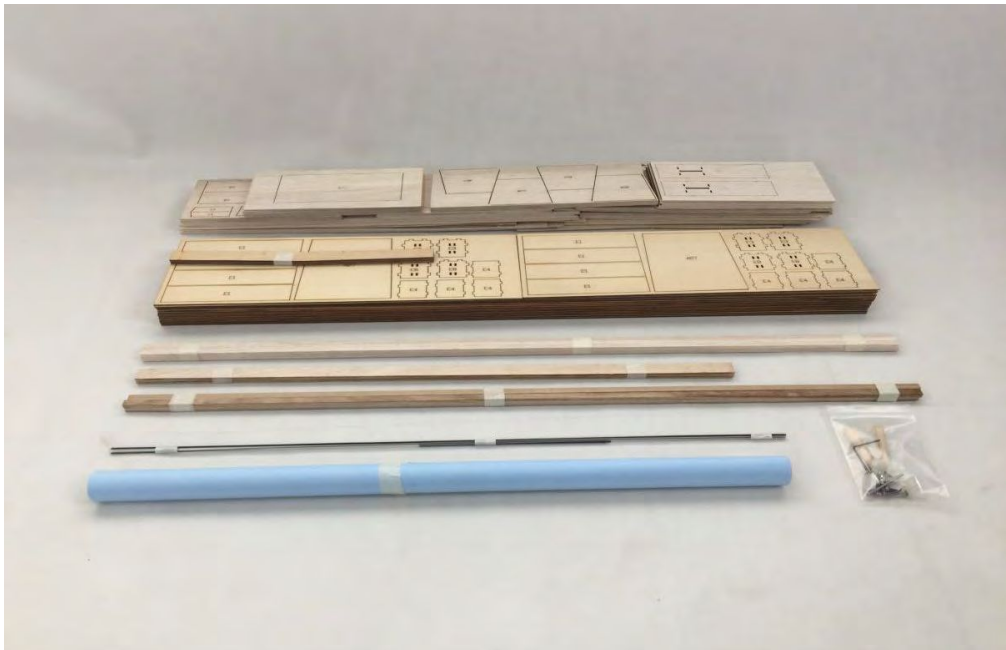

## KIT FEATURES

- High quality balsa and plywood construction.
- Easy to fly floatplane design.
- Excellent flight performance and handling qualities.
- Capable of taking off from water, grass and snow.
- Complete accessory pack.
- Extensive clear drawings and step by step instructions with pictures.
- Only adhesives and covering material required to complete the airframe.

## BUILDING INSTRUCTIONS

### Fuselage Assembly.



1. Select front former parts A4 and A5.

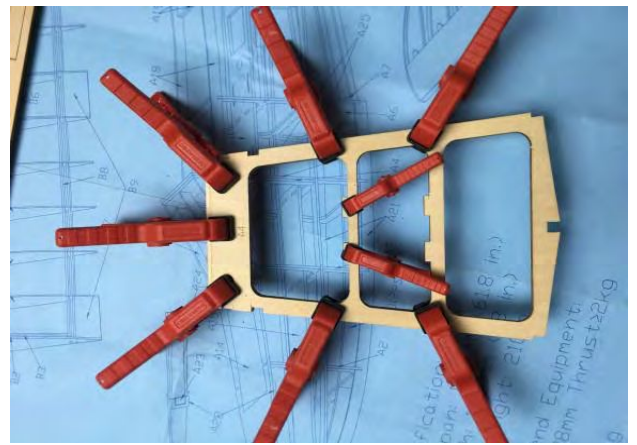

2. Glue the parts together as shown.

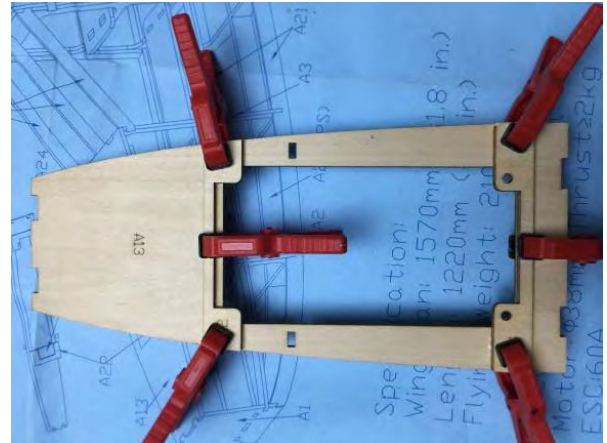

3. Glue parts A24 & A22 to part A13, the front fuselage top and battery access hatch.

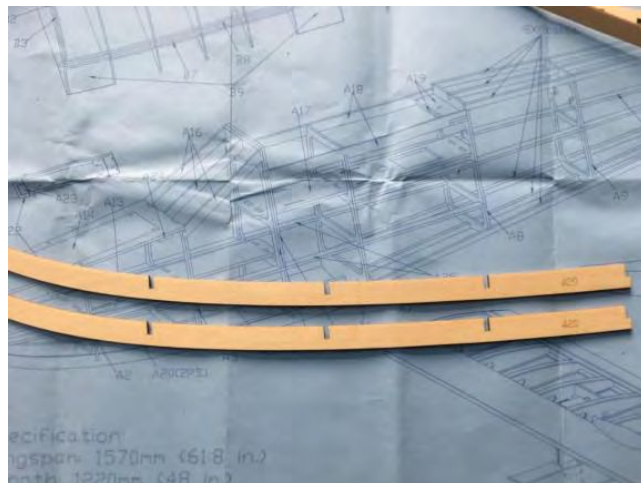

4. Glue together as a laminate the 2 x A20 parts to form part the keel.

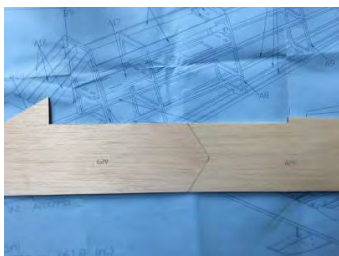

5. Glue together as shown the 4 off different shaped A29 pieces to make one fuselage side. Repeat this process to make the second fuselage side.

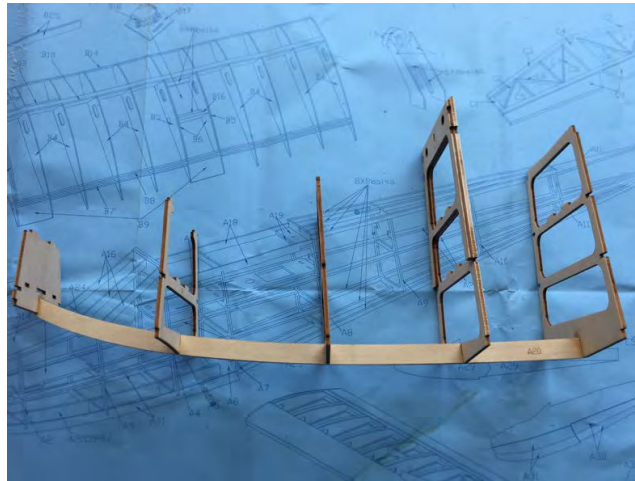

**6. Glue formers A1/A2/A3/A5 and A6 to the keel A20.**

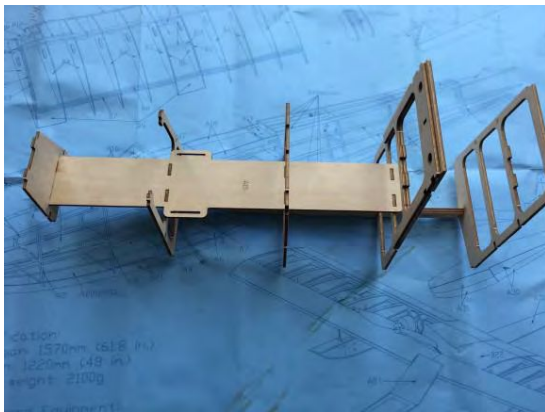

**7. Glue the battery mount A15 to the above assembly and the add the 3 off A16 to form the dummy windshield front bracing.**



**8. Glue the battery access hatch A13 assembly to the top of the front of the fuselage.**

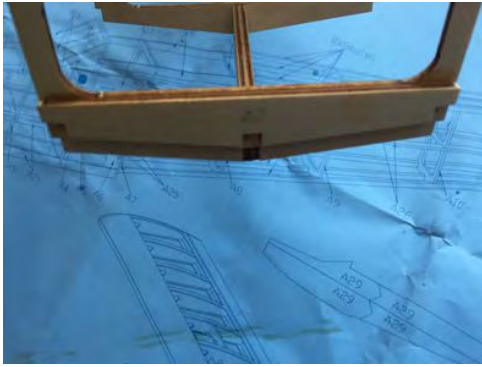

9. Glue part A7 to former A6.



10. Glue strips A21 to front base of fuselage.

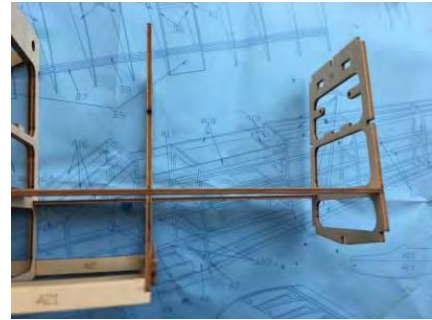

11. Glue strips A25 to the sides from the front nose former A1 back to the rear former A8.



12. Glue in place the radio tray part A17.

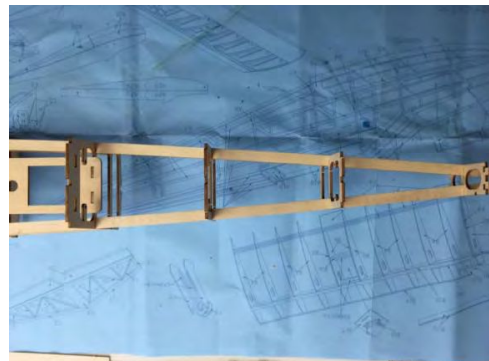
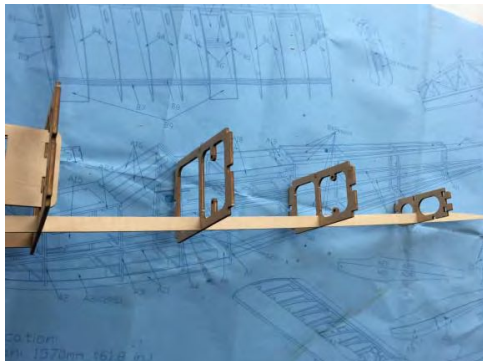

13. Glue the 2 off fuselage side strips A26 to formers A6 and A8. Ensure the tapered end of A26 goes to the rear. When dry, glue in formers A9/A10 and A11 into the notches in parts A26. Also at the point glue the rear of strips A26 together. Be careful at this point not to build a twist into the fuselage assembly.

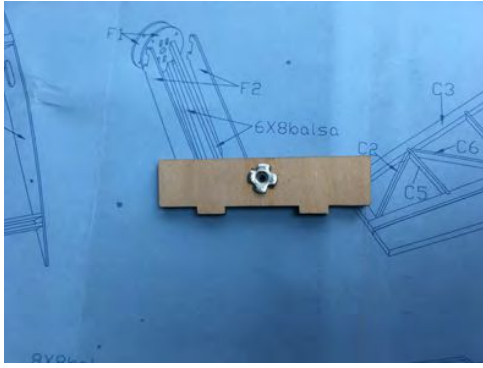

**14. Laminate together the 2 off wing fixing plates A19, when dry install the four-pronged blind nut as shown.**

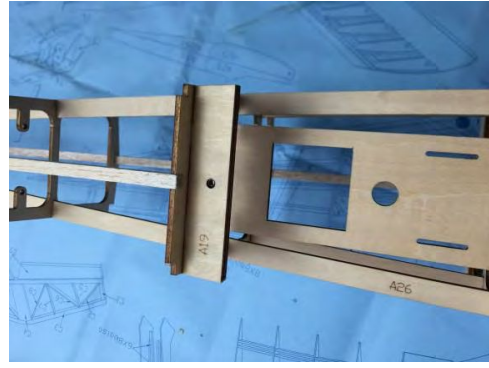

**15. Glue the prepared wing fixing plate A19 to the top former A8. Then add the 2 off wing seating strips A18.**



**16. Glue the 3 off 6x6mm balsa strips to the top of the fuselage from the rear wing seat former A8 down to the rearmost former A11. Glue these also to formers A9 and A10.**



**17. Then add the 2 off 6x6mm balsa strips to the bottom of the fuselage from former A7. These will require shaping at the rear as shown below then glued together (Please note these do not go to a point, the fuselage at the rear needs to be the same width as the rear of part A12). When these have set add the center bottom 6x6mm balsa strip from former A7 and shape it to fit in between the 2 outer strips as shown below. Be careful at this point not to build a twist into the fuselage assembly.**



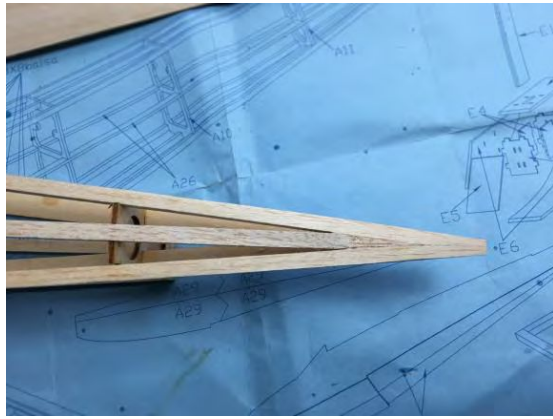

18. When these have set add the center bottom 6x6mm balsa strip from former A7 and shape it to fit in between the 2 outer strips as shown below.

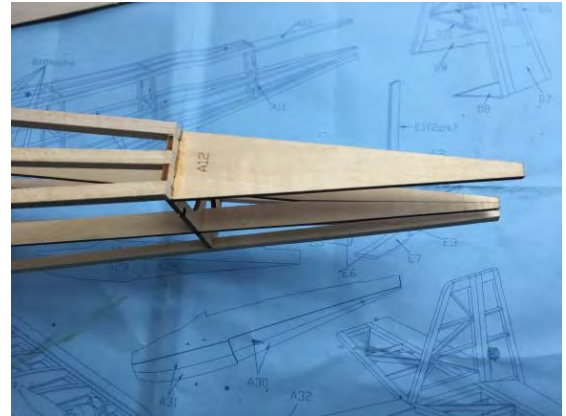

19. At this point add the horizontal stabilizer seat A12 to the rear of former A11.



20. Using a PVA or similar glue, attach the two balsa fuselage sides to the frame, use dress making pins or glass/plastic headed pins to hold them in place as the glue dries.



21. Install the 2 plastic push rod outer tubes into the fuselage as shown. They run from the radio compartment under the wing and exit on either side of the fuselage at the rear just under the horizontal stabilizer seat as shown above.



22. Cover the bottom of the rear fuselage with the balsa sheet parts A30. Once again use a good PVA glue and pins to hold them in place as the glue dries.

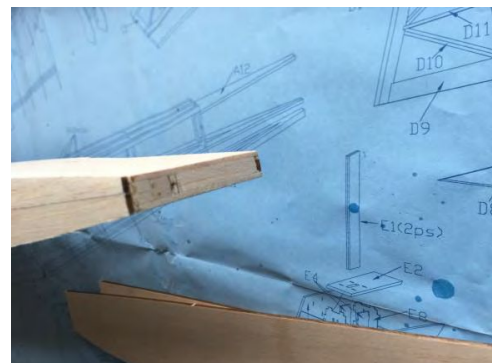

23. Fill in the rear of the fuselage with scrap balsa as shown. Width of the fuselage at the rear should match the stern post part D3, sand as necessary.



**24. Sheet in the underneath of the fuselage to form the hull using 2 off A31. Once again use a PVA type glue and hold in place with pins as the glue dries.**



**25. Sheet in the top rear of the fuselage using part A32.**



**26. Glue part A27 to the front of the fuselage to form the dummy windshield.**



**27. The nose is made up of 4 layers of part A28. Glue these together once again using a good quality PVA type glue as this will allow the nose to be easily sanded to shape when the glue has dried. Shape the nose as shown in the pictures above.**



28. Glue a pair of magnets to the battery hatch part A14.



29. Glue another pair of magnets to the corresponding part of the fuselage where the battery hatch fits. Ensure the polarity of the magnets are correct so that they attract and not repel.

The basic fuselage is now finished, sand the entire assembly and smooth and round off the corners.

### Wing Assembly. (Build the 2 wings on a flat surface to avoid any twisting)

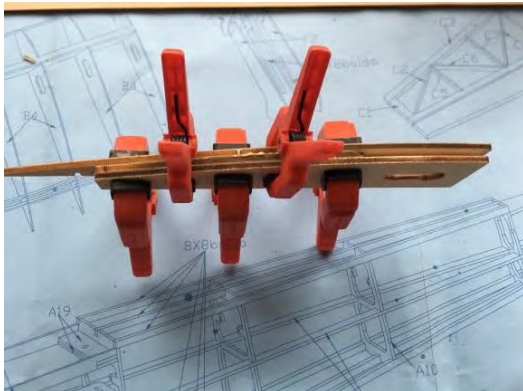

30. Laminate together the root ribs B1/B2 and B3. Note: B1 has a front piece which is added later.



31. Position and glue to the 2 off 6x8mm main spars, wing ribs B4 and B5, B5 are the center ribs. Also add the rear spars B7 and B8.

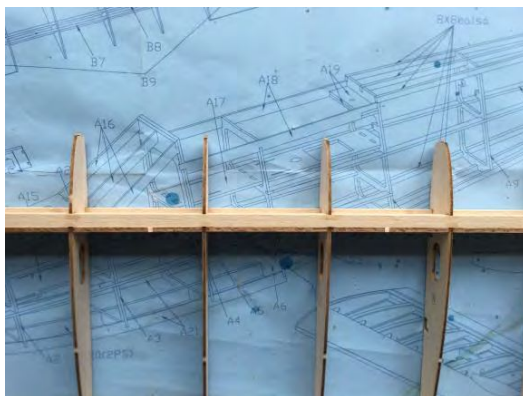

32. Add the vertical webbing B10 to the front 2 spars from underneath.



33. Add the root rib assembly that you laminated at step 30.



**34. Glue the reinforcing ribs B6 to the insides of ribs B5 so that they face each other.**

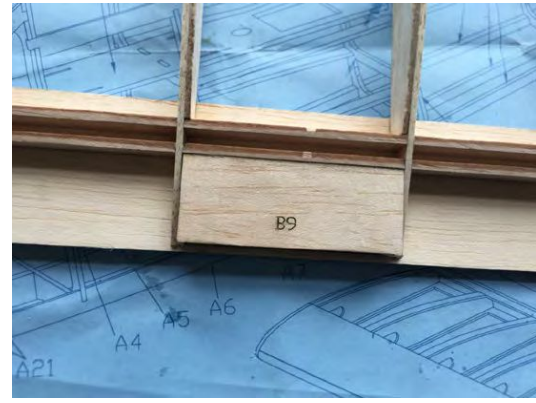

**35. Add the lower trailing edge sheeting to underneath the rear of the wing ribs. Sand the B9 balsa blocks to a taper and glue in between the rear of ribs B6.**



**36. Sand another B9 balsa block to a taper and glue in between the root rib B1 and the B4 rib next to it.**



**37. Trim the front of each rib just in front of the spar to fit the vertical webbing B13.**



**38. Glue B13 into position ensuring the hole for the front wing dowel is nearer the bottom than the top.**



**39. Add the leading edge B14 to the ribs as shown above.**



40. At this point the wings should look like this.



41. Glue to the front of the spar at the root the separate front part of rib B1. Then add the front wing dowel plate B11 and the half rib B12.



42. Glue to the leading the upper and lower balsa sheet B21. For this use a PVA type glue and pins to hold them in place as the glue dries.. Ensure the wings stay flat during the process.



43. Add 2 pieces of 6x8mm hardwood to the servo bay area as shown above.



44. Glue in place the reinforcing parts B16.



45. Add the top trailing edge sheeting B23 and the rib capping strips B24. The capping strips are glued to the top and bottom of the wing ribs in between the leading edge and trailing edge sheeting.



46. Glue into place the leading edge B15. When the glue has dried sand to the profile shown.



47. Using parts B17 and B18 construct the wing servo mount. These are also the wing float mounts, see further on in the manual.



48. Sand the trailing edge of the wings then glue 2mm balsa strips to the trailing edge.



49. Laminate 2 off B20 8mm balsa sheet together and glue to each wing tip.



50. Sand the wing tips to shape as shown. At this point the rest of the wing can be sanded as well to smooth out the joints.



**51. At this point you need to cut out the ailerons from the wings. Carefully measure this distance back from the trailing edge to the point between the 2 spars as shown.**



**52. Draw the cutting lines on the wing in pencil as shown above. Note: Do not cut them off right to the root, cut them so that the first rib in from the root becomes the end of the aileron.**



**53. Very carefully cut the ailerons off the wings. Insert the stiffeners D9 into the trailing edge of the wing where the aileron has been removed and glue into place.**



**54. Mark the ailerons as shown above to form a "V", sand or plane to shape to form the hinge line. Hinge the ailerons but do not glue the hinges in place, this will be done once the model is covered in film.**



55. Glue the 2 off B25 plywood parts together to form the wing dihedral brace. Before you join the wings test fit each one onto the fuselage, adjust as necessary. Trim the roots of each wing next to the spars to ensure the plywood dihedral brace fits snugly into each root up to the center of the brace. When happy with the fit glue the brace up to the center line into one wing only leaving the same amount sticking out.



56. When the glue has set on the dihedral brace in the first wing you are now ready to join the wings. Slide the second wing onto the brace and check the wing roots meet each other with a good joint, if not adjust/sand as necessary. Also check that the wings are perfectly aligned with each other with no twists. When satisfied with the fit and alignment apply glue to the wing roots and the brace and bring the 2 together. Wipe of any excess glue that squeezes out and support the wings at each wing tip to achieve the correct dihedral angle as the glue dries.



57. Glue into place the 2 off 8mm dowels to the front of the wing as shown above.



58. Carefully measure and mark the position of the wing trailing mounting bolt. Drill a 3mm hole then test fit the wing to the fuselage and screwing in the supplied 3mm wing bolt.





59. Drill the necessary holes for the aileron servo extension leads to pass through into the radio compartment. Please note that the aileron leads will need to be installed before wing is covered with film.

## Tail Assembly.

Build the the tail parts over the plan. Use a flat surface to avoid any twisting and use pins to hold to building board as glue dries. Tip: Rub soap onto the board/plan to avoid the parts sticking.

### Horizontal Stabilizer.



60. Glue together parts C4 and C10.



61. Add the 2 off C3 leading edge parts.



62. Add the 2 off tips, parts C1.



63. Add ribs C5 and C7 to both sides, glue in vertically into the slots in C3 and C10.



64. Add the diagonal bracing C2 and C6 to both sides.

Remove the assembly from the flat surface and sand the joints as necessary. Glue the horizontal stabilizer to the seat A12 at the rear of the fuselage. Ensure that it stays square to the fuselage as the glue dries.

## Rudder.



65. Glue parts D4/D5/D6 and D7 to form the frame of the rudder.

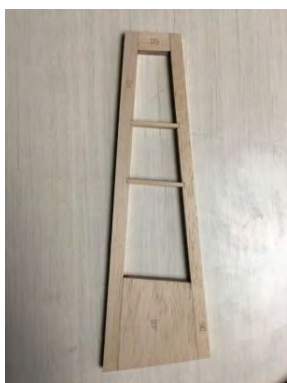

66. Add the horizontal braces D12 and D13.



67. Mark the leading edge of the rudder with a V as shown above for the hinge line.



68. Sand or plane the edges of the rudder in a V to form the hinge line.

## Horizontal Stabilizer.



69. Build the outer frame using parts D1/D2/D3 and D9.



70. Add the horizontal braces D10 and D11.



71. Trial fit the vertical stabilizer to the rear of the fuselage, adjust the fit by sanding or trimming as necessary. When satisfied with the fit glue into position, ensure it stays vertical to the fuselage as the glue dries. Once this has set add the rear skid/reinforcement part D8 as shown.



**72. Mark the leading edge of the elevators with a V as shown above for the hinge line.**



**73. Sand or plane the edges of the elevators in a V to form the hinge line.**



**74. Hinge the elevators but do not glue the hinges in place. Pass the elevator U shaped metal joiner through the gap behind the horizontal stabilizer and position it evenly on the elevators. Mark the position ready for drilling the holes.**



**75. Drill the holes on the hinge line of the elevators to accept the U shaped metal joiner.**



**76. Replace the elevators onto the joiner and the hinges but do not glue. Fit the hinges to the rudder/vertical stabilizer but do not glue these either. The hinges will be glued in place once the model has been covered with film.**

# Wing Float Assembly.

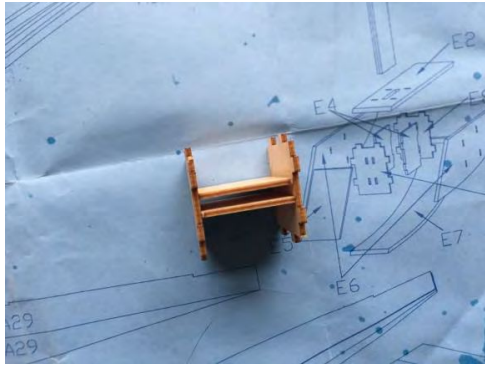

**77. Glue together parts E3/E4 and E8 as shown above.**

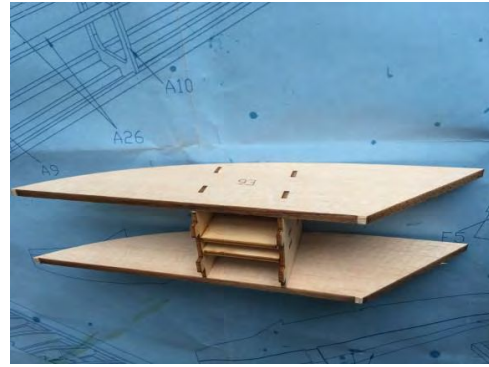

**78. Add to this sub assembly the 2 sides of the floats parts E6.**



**79. Add the top to the floats using part E2.**



**80. Form the underneath of the floats using part E7. Due to the curve these will require pinning in place as the glue dries.**



**81. Cap the backend of the floats using part E5.**



**82. Glue the float struts E1 to the floats. When dry, mark a line 80mm from the top of the float onto the strut.**



**83. Glue the struts to the servo mounts exactly on the 80mm mark so that they are both identical**



**84. Screw the servo mount/float assembly to the wing.**

## Motor Pylon Assembly.



85. Construct the motor pylon using 2 off parts F2 and 2 pieces of 6x8mm hardwood.



86. Laminate together to off F1 to form the motor mount.



87. Glue the motor mount to the pylon.

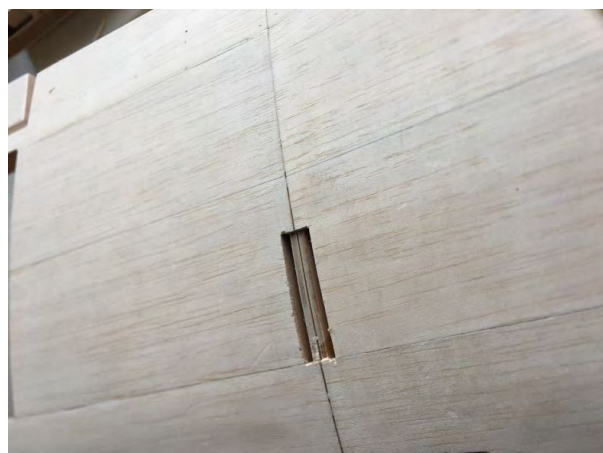

88. Cut the middle part of the wing at the point shown to accept the motor pylon.

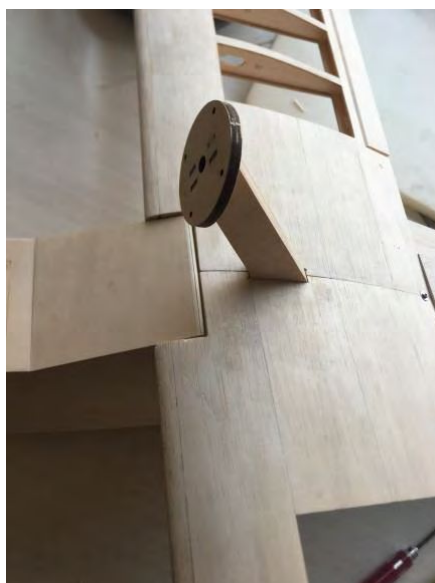

89. Glue the motor pylon securely to the wing, ensure the thrust angle is set at 5° up thrust.

90. Your Seagull Seaplane basic construction is finished, check it over and give it a final sanding where necessary. If you plan to fly it off of water then we recommend that you seal around all the glue joints with a waterproof sealer before covering.

91. Cover with a good quality covering film the separate components. These are the fuselage and tail parts, wings, ailerons, elevators and rudder.

92. Hinge the ailerons, elevators and rudder.

93. Attach to the control surfaces suitable control horns.

94. Install the motor, ESC, servos and push rods. If you are a relative newcomer to RC modeling then enlist the help of an inexperienced modeler to help finish the Seagull off.

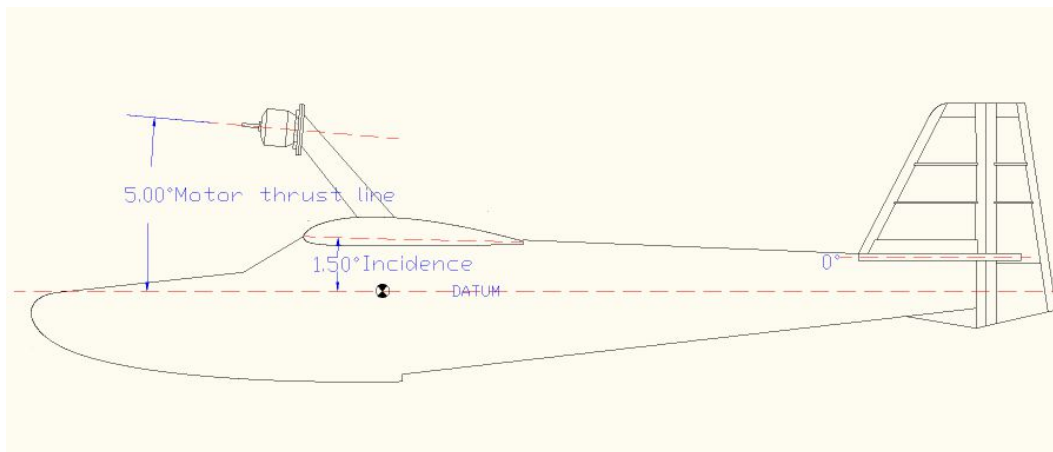

### Important Data:

1. Wing incidence: 1.5 degrees positive.
2. Tail incidence: 0 degrees.
3. Please refer to the plan for the center of gravity/balance point.